



Dresdener UKW-Runde

194. DUR – Aktivitätscontest Oktober 2024 – Ergebnisse

QRG	Call	Station	Loc.	QSOs	km	ODX	
23cm:	9A5M	100W, 200cm Spiegel	JN95GO	14	5311	OK2KKW;JO70FD;590km	
	HA3FMR	100W, 56El Yagi	JN97NM	10	3240	OK1PGS;JN69RS;486km	
	FM-QRP	DM4SWL	2W, YA-13	JO60LK	16	2175	OL1B;JO80IB;270km
	FM-QRP	DL1DSR	2W, YA-13	JO60LK	16	2175	OL1B;JO80IB;270km
		DG2DWL	10W, 20El Yagi	JO60TR	27	2166	DC7QH;JO62QN;205km
		DL1HTT	50W, 2x37El Yagi	JO61FR	6	1160	OM2RC;JN88OL;496km
	FM-QRP	DL2XF/P	2W-FM/25W-SSB, 14El Y.	JO71CD	18	948	DC7QH;JO62QN;168km
		DL1JIF/P	10W, 18El-HM-Yagi	JO61LC	9	760	OK1FQK;JO70NB;192km
		DL1HSF	80W, 120cm Spiegel	JO61XF	4	590	OK1PGS;JN69MX;199km
	FM-QRP	DO2UDX/P	2W, HM-Doppelquad	JO60UW	18	572	DM4SWL/p;JO60LK;77km
		DJ5AM	10W, 4x Dipol	JO61XE	12	571	DM4SWL;JO60LK;110km
	FM-QRP	DL1HUF/P	2.5W, 5El Yagi	JO61XK	6	526	DM4SWL;JO60LK;131km
		DL6AST	20W, 24El Yagi	JO60GQ	2	438	DG5BRE;JO62VM;222km
		9A1I	10W, 67El Yagi	JN85FS *	4	418	9A2UV;JN95GM;165km
		YO3FWL	20W, DJ9BV-Ant.	KN24XL	4	289	YO4FYQ;KN44FD;203km
		DM2EUN	100W, 45El Yagi	JO60IV	4	288	DL1HTT;JO61FR;95km
		YO9AYN/P	100W, 49El Yagi	KN24RX	3	218	YO3GJ;KN34AK;76km
	FM-QRP	DM6JKC	2W, 8El Yagi	JO60NP	4	188	DD1UDW;JO60UT;59km
		DL6DVU	10W, Doppelquad	JO61VB	5	107	DO2UDX;JO60TR;39km
		DL8WQQ	10W, 100cm Spiegel	JO61II	1	95	DG2DWL;JO60TR;95km
		DF0MTL	10W, 100cm Spiegel	JO61II	1	95	DG2DWL;JO60TR;95km
		DL5DTL	10W, Doppelquad	JO61VC	4	92	DG2DWL;JO60TR;43km
		YO3GJ	2W, 2El Yagi	KN34AK	3	90	YO9AYN/P;KN24RX;76km
	YO3GNF	25W, 14dBi-Panel	KN34AL	3	85	YO9AYN/P;KN24RX;73km	
	DL3MR	10W, 20El Yagi	JO71DC	2	52	DL1HUF/P;JO61XK;44km	
13cm:	DG2DWL	5W, 40El Yagi	JO60TR	14	1188	DC7QH;JO62QN;205km	
	9A5M	20W, 200cm Spiegel	JN95GO	5	1014	OE3JPC;JN87EW;308km	
	DL2XF/P	20W, Planarant. 2.3-02	JO71CD	11	712	DC7QH;JO62QN;168km	
	DL1DSR	2W, YA-17	JO60LK	6	616	DD0VD/P;JO71DO;160km	
	DM4SWL	2W, YA-17	JO60LK	6	616	DD0VD/P;JO71DO;160km	
	DO2UDX/P	2W, PAT2314	JO60UW	12	507	DD0VD/p;JO71DO;85km	
	DL1HSF	50W, 120cm Spiegel	JO61FR	3	391	DM4SWL;JO60LK;148km	
	DM2EUN	175W, 64El Yagi	JO60IV	4	271	DL1HSF;JO61FR;95km	
	YO3GNF	1W, 17dBi-Panel	KN34AL	4	264	YO9GOO/P;KN25UG;92km	
	YO3FWL	2W, 24dBi-Grid	KN24XL	4	259	YO3GWM/P;KN25UG;91km	
	YO3GWM/P	2W, 24dBi-Grid	KN25UG	3	221	YO3GNF;KN34AL;92km	
	YO9AYN/P	100W, PG-24	KN24RX	4	218	YO3GNF;KN34AL;73km	
	DJ5AM	2W, Quad-Antenne	JO61XE	6	209	DG2DWL;JO60TR;57km	
	DL6DVU	2W, Patchantenne	JO61VB	3	55	DL2XF;JO71CD;31km	
09cm:	DM4SWL	3W, Flat-Antenne	JO60LK	5	764	DC7QH;JO62QN;239km	
	(x2)	DL1DSR	3W, Panel	JO60LK	5	764	DC7QH;JO62QN;239km
		DL1HSF	20W, 120cm Spiegel	JO61FR	3	391	DM4SWL;JO60LK;148km
		DM2EUN	20W, 80/60cm Gittersp.	JO60IV	3	203	DL1HSF;JO61FR;95km
		DJ5AM	mW Pluto SDR, PCB LP	JO61XE	1	28	DL4DTU;JO61TB;28km
06cm:	YO9AYN/P	200mW, Svenska-Spiegel	KN24RX	3	218	YO3GJ;KN34AK;76km	
		YO8RHM	1W, Septum-Feet cirk.	KN38JF	1	173	YO8CLN;KN27OC;173km
		YO8CLN	2W, 60cm Spiegel	KN27OC	1	173	YO8RHM;KN38JF;173km
		YO3GJ	200mW, Grid-Antenne	KN34AK	3	90	YO9AYN/P;KN24RX;76km
		YO3FWL	1W, Svenska 60cm 28dBi	KN24XL	3	85	YO9AYN/P;KN24RX;69km
		YO3GNF	200mW, 23dBi-Panel	KN34AL	3	85	YO9AYN/P;KN24RX;73km

Im Frühjahr machten mehrere OMs den Vorschlag, den DUR-Contest zeitlich auszuweiten. Zum Ende des Jahres könnten wir die Ausschreibung ändern, um damit im Januar 2025 mit neuen Zeiten zu starten. In der laufenden Saison war das leider nicht möglich. Zur Übersicht mal einige Aktivitätsconteste, die jeweils am dritten Sonntag im Monat laufen. (HB9 und SP arbeiten zugleich mit OZ/SM... jeweils am Dienstagabend.) Bitte (nochmal) Eure Vorschläge senden, damit wir darüber diskutieren können, mni tnx.



9A Activity Contest	(6m - Laser)	07:00 - 12:00 UTC
S5 Activity	(50MHz - GHz)	07:00 - 12:59
OK Activity Contest	(144MHz - 10GHz)	08:00 - 11:00
DUR-GHz-Aktivität	(23cm - Licht)	08:00 - 11:00
OE Aktivitätscontest	(6m - Licht)	07:00 - 13:00
YO-SHF-Marathon	(23cm - 3cm, April-Nov)	07:00 - 11:59

Bitte auch die 1297.500/ 2321.475 (SBW) in FM für die Bergfunker aktivieren. #
 # SSB - Stationen: Bitte jede volle und halbe Stunde auf die FM-QRG schalten. #

QRG	Call	Station	Loc.	QSOs	km	ODX
03cm:	DM2MM	5W, 45cm Spiegel	JO62XV	12	2070	DL6NAA; JO50VF; 332km
	DO1UKA	4W, 48cm Spiegel	JO71FE	10	1570	DL5AAJ; JO51LW; 256km
	DL7UDA	10W, 68cm Offsetsp.	JO62VO	7	961	DL6NAA; JO50VF; 299km
	DL7VTX/P	2W, 33cm Spiegel	JO74AA	5	893	DL4DTU; JO61TB; 330km
	DL2DRG	8W, 45cm Spiegel	JO70JU	4	386	DM2MM; JO62VX; 247km
	9A5M	10W, 140cm Spiegel	JN95GO	2	269	9A1W; JN75ST; 235km
	DM2EUN	10W, 60cm Spiegel	JO60IV	1	205	DL7UDA; JO62VO; 205km
	YO8CLN	500mW, 50cm Spiegel	KN27OC	1	173	YO8RHM; KN38JF; 173km
	YO8RHM	2W, 60cm Offsetsp.	KN38JF	1	173	YO8CLN; KN27OC; 173km
	DJ5AM	2W, 60cm Spiegel	JO61XE	1	28	DL4DTU; JO61TB; 28km
	YO3FWL	2W, 40cm Offsetsp.	KN24XL	2	16	YO3GJ; KN34AK; 9km
	YO3GJ	200mW, 70cm Offsetsp.	KN34AK	2	14	YO3FWL; KN24XL; 9km
	YO3GNF	8W, 60cm Offsetsp.	KN34AL	2	12	YO3FWL; KN24XL; 7km
24GHz:	DM2EUN	2W, 60cm Spiegel	JO60IV	2	108	DM4SWL; JO60LK; 54km
	DM2MM	2.5W, 33cm Offsetsp.	JO62XV	2	108	DC7QH; JO62QN; 54km
	DL7UDA	2W, 40cm Spiegel	JO62VO	2	58	DC7QH; JO62QN; 29km
	DL1DSR	300mW, 66cm Spiegel	JO60LK	1	54	DM2EUN; JO60IV; 54km
	DM4SWL	300mW, 66cm Spiegel	JO60LK	1	54	DM2EUN; JO60IV; 54km
	DJ5AM	100mW, 20cm Horn	JO61XE	1	28	DL4DTU; JO61TB; 28km
	YO3GNF	2W, 40cm Offsetsp.	KN34AL	2	12	YO3FWL; KN24XL; 7km
	YO3FWL	2W, 40cm Offsetspiegel	KN24XL	1	7	YO3GNF; KN34AL; 7km
	YO3GJ	2W, Offsetsp.	KN34AK	1	5	YO3GNF; KN34AL; 5km
	47GHz:					
>300GHz						

* some QSOs outside DUR-Time 08:00-11:00 UTC

Stimmen zum Wettbewerb:

Mihai, YO8RHM (2m agl., 280m asl.): A very pleasant autumn weather with sun, no wind but with temperatures of -2 degrees :( and  with the setup for 6cm with SM6FHZ septum feed (circular). It is placed on the offset arm for 6cm. With this setup I worked at 172km with YO8CLN (asl. 2000m). Xvtr made by YO4HFU.
https://www.qsl.net/yo4hfu/Transverter_5.7GHz_Portable.html

Gheorge, YO8CLN (3m agl., 2021m asl): QTH: Calimani Retitis peak

Lennart, DM2MM (1m agl., 81m asl.): Ich war diesmal aus JO62XV (nr Brodowin) QRV. Hintergrund war der portable Einsatz von DL7VTX, Jens aus JO74AA. Der Locator fehlt mir noch auf 24 GHz, leider hat es wieder mal nicht geklappt. Ein Versuch war es dennoch wert. Auf 10 GHz hat es dagegen recht gut funktioniert. Die weiteste Verbindung war zu DL6NAA, Reinhold mit 332 km. Sehr bedauerlich war der Technikausfall bei DM4SWL, Günther. Die Verbindung auf 10 GHz zum Fichtelberg war schon fest eingeplant. Im Vorfeld hatte ich auch SP1N, Maciej (nr Szczecin) für einen Sked auf 24 GHz angeschrieben, leider waren er und die gesamte Mannschaft zu einem 24-GHz-Treffen in der Nähe von Koszalin. Auf 24 GHz tut seit einiger Zeit sehr viel in SP. Wie immer ein gelungener Einsatz bei gutem Wetter. Viele Grüße und vielen Dank, 73 de Lennart, DM2MM.

Alex, DL2XF: (21m agl., 405m asl.): Dieses Mal hatte ich mich für den Butterberg bei Bischofswerda entschieden. Ich wollte einen Standort wählen, den ich dieses Jahr noch nicht befunkt hatte (für neue Berg-zu-Berg-Punkte für den SBW), mit max. 1 h Anfahrtszeit, aber dennoch nicht zu niedrig, und mit Turm. Leider hat man vom Butterbergturm nur in wenige Sektoren eine freie Horizontsicht, da die Bäume inzwischen höher sind. Außerdem gibt es einen kommerziellen Sendemast auf dem Berg, der insbesondere auf 70 cm im preiswerten Handfunkgerät Störungen verursacht. Auf 23 cm in SSB waren die typischen "Klingelstörungen" besonders stark, was aber nicht lokal vom Berg verursacht sein muss. Jedenfalls hatte ich die Hoffnung auf eine Verbindung nach Berlin schon fast aufgegeben, dann klappte es aber noch kurz vor Schluß auf FM. Auf 13 cm in SSB keinerlei Störungen. Schön war auch der Kontakt zum Fichtelberg mit QRP auf 23 cm - auf 13 cm blieb der Einfachheit halber die PA bei mir aktiv, aber das hätte sicher auch mit kleiner Leistung funktioniert. Man sollte noch erwähnen, dass die Aussichtsplattform über der Küchenentlüftung liegt. Also für mich wars nach ein paar Stündchen da oben eher der "Bratfettberg" als der Butterberg... 73, Alex.

André, DL6AST: War leider nur kurz dabei.

Marc, DO2UDX (1m agl., 425m asl.): Dieses mal ging es wieder auf den Lerchenberg, mehr war gesundheitlich leider nicht drin. Dieses mal aber bei deutlich besserem Wetter sind wieder schöne Verbindungen in's Log gekommen.

Marin, 9A5M (18m agl., 109m asl.): Helou OM, Please send your log on 9A robot
<https://www.hamradio.hr/vhfrobot/index.php> Also nice calendar VHFup on
https://www.hamradio.hr/dacc/ukv_kalendar.php?Lng=english GL, Marin, 9A5M.

Gerald, DL1DSR (2m agl., 1215m asl.): Der Oktober zeigte sich nochmals von seiner besten Seite. Im Erzgebirge hatten wir auf dem Fichtelberg Glück, schon morgens über den Nebelfeldern zu stehen. Allerdings frischte der Wind im Laufe des Vormittags auf, so dass trotz Fels-Gewichten das 9-cm-Stativ wegzufiegen drohte. Leider wollte sich die 10-GHz-Station nicht mit den guten Bedingungen arrangieren und versagte den aktiven Dienst. Für die von Norbert, DL4DTU, geliehene 47-GHz-Station fanden sich erneut keine erreichbaren Gegenstationen.

Günther, DM4SWL (2m agl., 1215m asl.): DUR Oktober 2024 vom Fichtelberg - JO60LK. Diesmal ohne 3cm-Wertung. Leider war die Anlage defekt... Hier noch ein Hinweis zum "Sächsischen Bergwettbewerb 2024"- Wertungsklasse "höher 13cm": Alle Teilnehmer der DUR-Conteste, die 2024 QSO's mit sächsischen Bergen getätigt haben, können diese am Jahresende einreichen. Jeder Teilnehmer erhält eine Urkunde. In diesem Jahr sind bisher 23 sächsische Berge von verschiedenen Stationen aktiviert worden. Wir würden uns über viele Abrechner freuen. Rückfragen an DM4SWL - sperling.g@gmx.de. Ausschreibung SBW: http://www.dl2lto.de/SBW/sc/SBW_oneside_index.htm.

Roland, DM2EUN (11m agl., 320m asl.): Anbei einige Bilder von meinem neuem Portabletransverter für 6cm (1,2W). Ohne die Hilfe von DL4PT hätte ich die teilweise 1,5x1,5mm großen IC's niemals auf die Leiterplatte bekommen (tnx Friedrich!). Übrigens ist der kürzlich von mir vorgestellte Gitterspiegel für 6cm abzugeben. Passt nicht mehr an meinem Mast. 73.



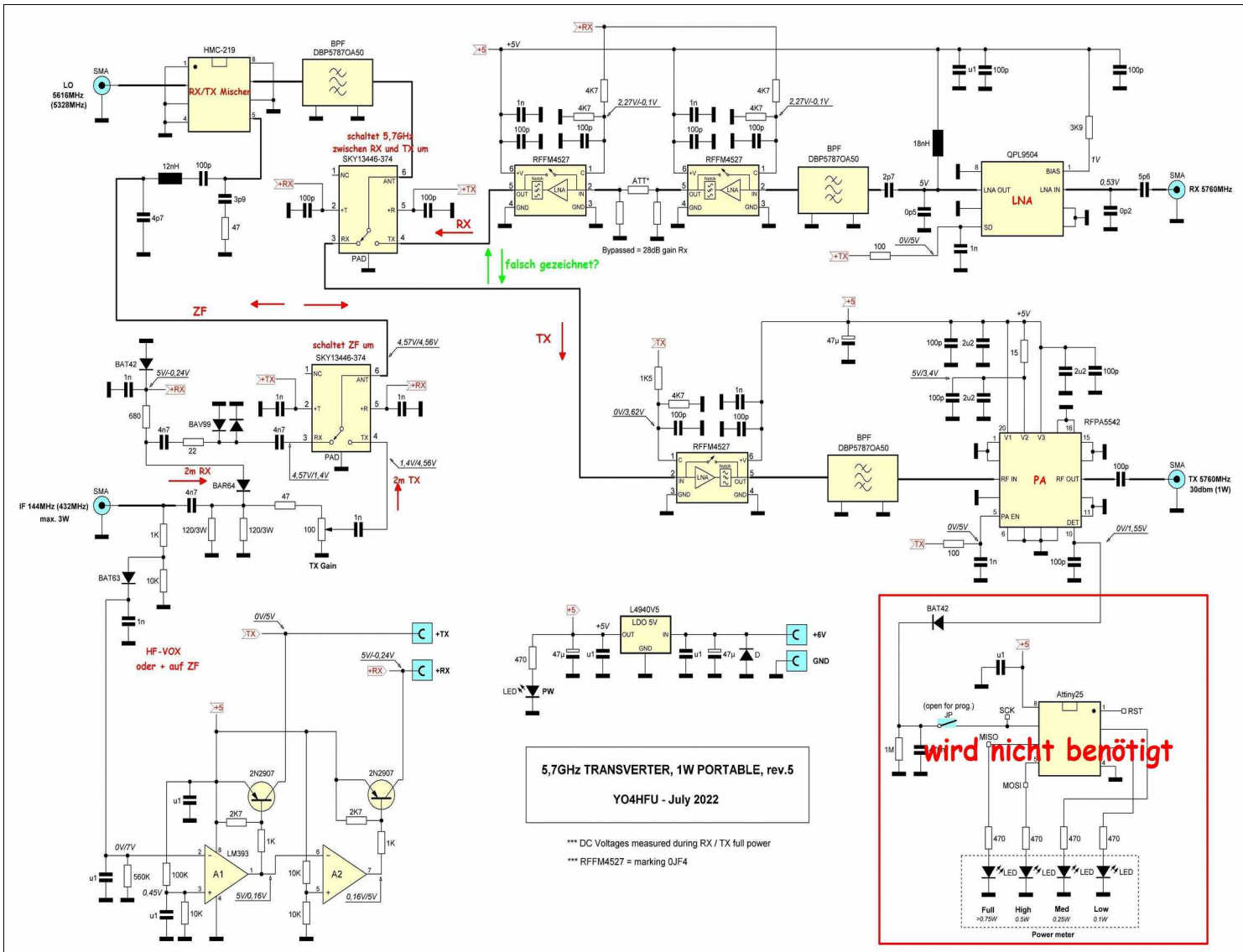
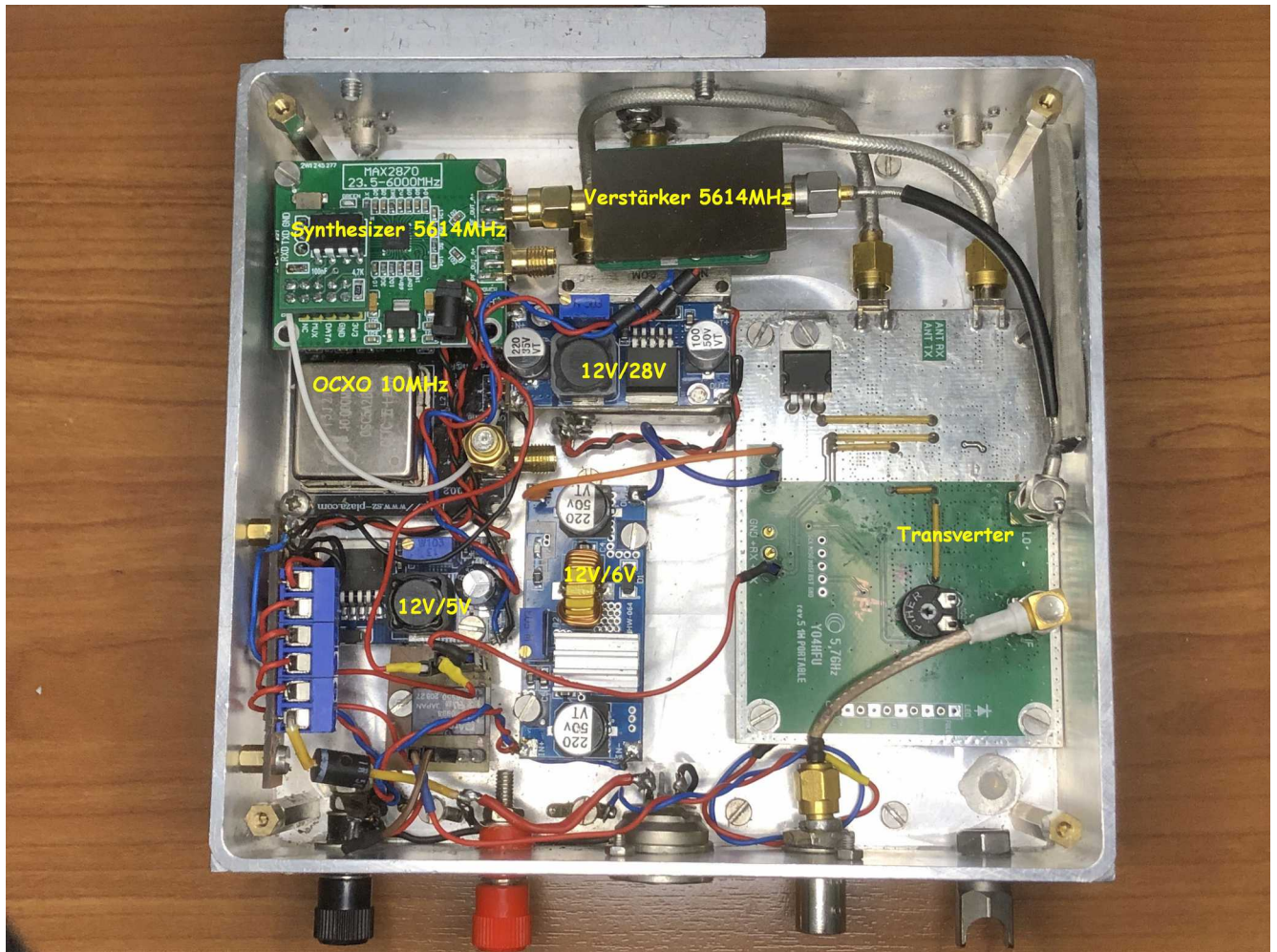



Mihai - (YO8RHM) - Transverter 6cm with SM6FHZ septum feed (circular)

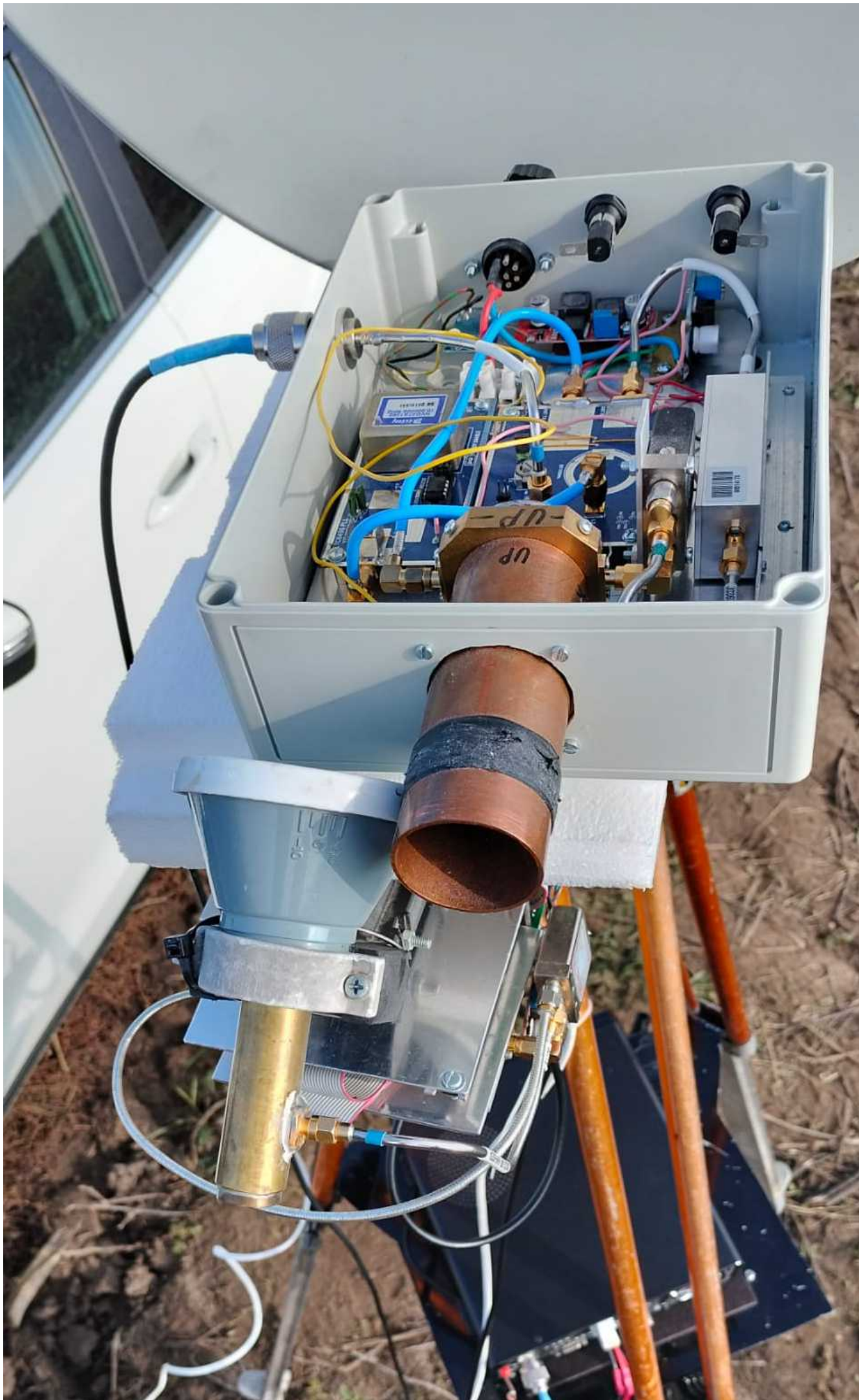



Jens, DL7VTX auf Usedom, JO74AA





Alex, DL2XF, auf dem Butterberg bei Bischofswerda



Der Blick vom Butterberg-Turm in JO71CD aus 21m Höhe



Gheorge, YO8CLN, 2021m ü. NN: QTH: Calimani Retitis peak (KN270C)



Marcus (DO2UDX) Station wieder auf dem Lerchenberg (JO60UW)

Fichtelberg/Erzgebirge, 1215 m üNN
JO60LK, DA/SX-282, DLFF-0056
Günther, DM4SWL - Gerald, DL1DSR
DUR-Contest - 20. Oktober 2024

DL1DSR JO60LK																																																																																																																																																																																																																																																																																																																																																																																																																																																											
log start	20-Oct-2024	08:34																																																																																																																																																																																																																																																																																																																																																																																																																																																									
log end	20-Oct-2024	18:56																																																																																																																																																																																																																																																																																																																																																																																																																																																									
operating period	2 hours 22 min																																																																																																																																																																																																																																																																																																																																																																																																																																																										
operating time	2 hours 22 min																																																																																																																																																																																																																																																																																																																																																																																																																																																										
off time	23 hours 8 min																																																																																																																																																																																																																																																																																																																																																																																																																																																										
QSOs	28																																																																																																																																																																																																																																																																																																																																																																																																																																																										
CW	2																																																																																																																																																																																																																																																																																																																																																																																																																																																										
Phone	26																																																																																																																																																																																																																																																																																																																																																																																																																																																										
<table border="1" style="font-size: x-small;"> <thead> <tr> <th>Band</th> <th>QSOs</th> <th>CW</th> <th>Phone</th> <th>Total</th> </tr> </thead> <tbody> <tr> <td>160m</td> <td>0</td> <td>0</td> <td>0</td> <td>0</td> </tr> <tr> <td>170m</td> <td>0</td> <td>0</td> <td>0</td> <td>0</td> </tr> <tr> <td>175m</td> <td>0</td> <td>0</td> <td>0</td> <td>0</td> </tr> <tr> <td>180m</td> <td>0</td> <td>0</td> <td>0</td> <td>0</td> </tr> <tr> <td>185m</td> <td>0</td> <td>0</td> <td>0</td> <td>0</td> </tr> <tr> <td>190m</td> <td>0</td> <td>0</td> <td>0</td> <td>0</td> </tr> <tr> <td>200m</td> <td>0</td> <td>0</td> <td>0</td> <td>0</td> </tr> <tr> <td>210m</td> <td>0</td> <td>0</td> <td>0</td> <td>0</td> </tr> <tr> <td>220m</td> <td>0</td> <td>0</td> <td>0</td> <td>0</td> </tr> <tr> <td>230m</td> <td>0</td> <td>0</td> <td>0</td> <td>0</td> </tr> <tr> <td>240m</td> <td>0</td> <td>0</td> <td>0</td> <td>0</td> </tr> <tr> <td>250m</td> <td>0</td> <td>0</td> <td>0</td> <td>0</td> </tr> <tr> <td>260m</td> <td>0</td> <td>0</td> <td>0</td> <td>0</td> </tr> <tr> <td>270m</td> <td>0</td> <td>0</td> <td>0</td> <td>0</td> </tr> <tr> <td>280m</td> <td>0</td> <td>0</td> <td>0</td> <td>0</td> </tr> <tr> <td>290m</td> <td>0</td> <td>0</td> <td>0</td> <td>0</td> </tr> <tr> <td>300m</td> <td>0</td> <td>0</td> <td>0</td> <td>0</td> </tr> <tr> <td>310m</td> <td>0</td> <td>0</td> <td>0</td> <td>0</td> </tr> <tr> <td>320m</td> <td>0</td> <td>0</td> <td>0</td> <td>0</td> </tr> <tr> <td>330m</td> <td>0</td> <td>0</td> <td>0</td> <td>0</td> </tr> <tr> <td>340m</td> <td>0</td> <td>0</td> <td>0</td> <td>0</td> </tr> <tr> <td>350m</td> <td>0</td> <td>0</td> <td>0</td> <td>0</td> </tr> <tr> <td>360m</td> <td>0</td> <td>0</td> <td>0</td> <td>0</td> </tr> <tr> <td>370m</td> <td>0</td> <td>0</td> <td>0</td> <td>0</td> </tr> <tr> <td>380m</td> <td>0</td> <td>0</td> <td>0</td> <td>0</td> </tr> <tr> <td>390m</td> <td>0</td> <td>0</td> <td>0</td> <td>0</td> </tr> <tr> <td>400m</td> <td>0</td> <td>0</td> <td>0</td> <td>0</td> </tr> <tr> <td>410m</td> <td>0</td> <td>0</td> <td>0</td> <td>0</td> </tr> <tr> <td>420m</td> <td>0</td> <td>0</td> <td>0</td> <td>0</td> </tr> <tr> <td>430m</td> <td>0</td> <td>0</td> <td>0</td> <td>0</td> </tr> <tr> <td>440m</td> <td>0</td> <td>0</td> <td>0</td> <td>0</td> </tr> <tr> <td>450m</td> <td>0</td> <td>0</td> <td>0</td> <td>0</td> </tr> <tr> <td>460m</td> <td>0</td> <td>0</td> <td>0</td> <td>0</td> </tr> <tr> <td>470m</td> <td>0</td> <td>0</td> <td>0</td> <td>0</td> </tr> <tr> <td>480m</td> <td>0</td> <td>0</td> <td>0</td> <td>0</td> </tr> <tr> <td>490m</td> <td>0</td> <td>0</td> <td>0</td> <td>0</td> </tr> <tr> <td>500m</td> <td>0</td> <td>0</td> <td>0</td> <td>0</td> </tr> <tr> <td>510m</td> <td>0</td> <td>0</td> <td>0</td> <td>0</td> </tr> <tr> <td>520m</td> <td>0</td> <td>0</td> <td>0</td> <td>0</td> </tr> <tr> <td>530m</td> <td>0</td> <td>0</td> <td>0</td> <td>0</td> </tr> <tr> <td>540m</td> <td>0</td> <td>0</td> <td>0</td> <td>0</td> </tr> <tr> <td>550m</td> <td>0</td> <td>0</td> <td>0</td> <td>0</td> </tr> <tr> <td>560m</td> <td>0</td> <td>0</td> <td>0</td> <td>0</td> </tr> <tr> <td>570m</td> <td>0</td> <td>0</td> <td>0</td> <td>0</td> </tr> <tr> <td>580m</td> <td>0</td> <td>0</td> <td>0</td> <td>0</td> </tr> <tr> <td>590m</td> <td>0</td> <td>0</td> <td>0</td> <td>0</td> </tr> <tr> <td>600m</td> <td>0</td> <td>0</td> <td>0</td> <td>0</td> </tr> <tr> <td>610m</td> <td>0</td> <td>0</td> <td>0</td> <td>0</td> </tr> <tr> <td>620m</td> <td>0</td> <td>0</td> <td>0</td> <td>0</td> </tr> <tr> <td>630m</td> <td>0</td> <td>0</td> <td>0</td> <td>0</td> </tr> <tr> <td>640m</td> <td>0</td> <td>0</td> <td>0</td> <td>0</td> </tr> <tr> <td>650m</td> <td>0</td> <td>0</td> <td>0</td> <td>0</td> </tr> <tr> <td>660m</td> <td>0</td> <td>0</td> <td>0</td> <td>0</td> </tr> <tr> <td>670m</td> <td>0</td> <td>0</td> <td>0</td> <td>0</td> </tr> <tr> <td>680m</td> <td>0</td> <td>0</td> <td>0</td> <td>0</td> </tr> <tr> <td>690m</td> <td>0</td> <td>0</td> <td>0</td> <td>0</td> </tr> <tr> <td>700m</td> <td>0</td> <td>0</td> <td>0</td> <td>0</td> </tr> <tr> <td>710m</td> <td>0</td> <td>0</td> <td>0</td> <td>0</td> </tr> <tr> <td>720m</td> <td>0</td> <td>0</td> <td>0</td> <td>0</td> </tr> <tr> <td>730m</td> <td>0</td> <td>0</td> <td>0</td> <td>0</td> </tr> <tr> <td>740m</td> <td>0</td> <td>0</td> <td>0</td> <td>0</td> </tr> <tr> <td>750m</td> <td>0</td> <td>0</td> <td>0</td> <td>0</td> </tr> <tr> <td>760m</td> <td>0</td> <td>0</td> <td>0</td> <td>0</td> </tr> <tr> <td>770m</td> <td>0</td> <td>0</td> <td>0</td> <td>0</td> </tr> <tr> <td>780m</td> <td>0</td> <td>0</td> <td>0</td> <td>0</td> </tr> <tr> <td>790m</td> <td>0</td> <td>0</td> <td>0</td> <td>0</td> </tr> <tr> <td>800m</td> <td>0</td> <td>0</td> <td>0</td> <td>0</td> </tr> <tr> <td>810m</td> <td>0</td> <td>0</td> <td>0</td> <td>0</td> </tr> <tr> <td>820m</td> <td>0</td> <td>0</td> <td>0</td> <td>0</td> </tr> <tr> <td>830m</td> <td>0</td> <td>0</td> <td>0</td> <td>0</td> </tr> <tr> <td>840m</td> <td>0</td> <td>0</td> <td>0</td> <td>0</td> </tr> <tr> <td>850m</td> <td>0</td> <td>0</td> <td>0</td> <td>0</td> </tr> <tr> <td>860m</td> <td>0</td> <td>0</td> <td>0</td> <td>0</td> </tr> <tr> <td>870m</td> <td>0</td> <td>0</td> <td>0</td> <td>0</td> </tr> <tr> <td>880m</td> <td>0</td> <td>0</td> <td>0</td> <td>0</td> </tr> <tr> <td>890m</td> <td>0</td> <td>0</td> <td>0</td> <td>0</td> </tr> <tr> <td>900m</td> <td>0</td> <td>0</td> <td>0</td> <td>0</td> </tr> <tr> <td>910m</td> <td>0</td> <td>0</td> <td>0</td> <td>0</td> </tr> <tr> <td>920m</td> <td>0</td> <td>0</td> <td>0</td> <td>0</td> </tr> <tr> <td>930m</td> <td>0</td> <td>0</td> <td>0</td> <td>0</td> </tr> <tr> <td>940m</td> <td>0</td> <td>0</td> <td>0</td> <td>0</td> </tr> <tr> <td>950m</td> <td>0</td> <td>0</td> <td>0</td> <td>0</td> </tr> <tr> <td>960m</td> <td>0</td> <td>0</td> <td>0</td> <td>0</td> </tr> <tr> <td>970m</td> <td>0</td> <td>0</td> <td>0</td> <td>0</td> </tr> <tr> <td>980m</td> <td>0</td> <td>0</td> <td>0</td> <td>0</td> </tr> <tr> <td>990m</td> <td>0</td> <td>0</td> <td>0</td> <td>0</td> </tr> <tr> <td>1000m</td> <td>0</td> <td>0</td> <td>0</td> <td>0</td> </tr> </tbody> </table>				Band	QSOs	CW	Phone	Total	160m	0	0	0	0	170m	0	0	0	0	175m	0	0	0	0	180m	0	0	0	0	185m	0	0	0	0	190m	0	0	0	0	200m	0	0	0	0	210m	0	0	0	0	220m	0	0	0	0	230m	0	0	0	0	240m	0	0	0	0	250m	0	0	0	0	260m	0	0	0	0	270m	0	0	0	0	280m	0	0	0	0	290m	0	0	0	0	300m	0	0	0	0	310m	0	0	0	0	320m	0	0	0	0	330m	0	0	0	0	340m	0	0	0	0	350m	0	0	0	0	360m	0	0	0	0	370m	0	0	0	0	380m	0	0	0	0	390m	0	0	0	0	400m	0	0	0	0	410m	0	0	0	0	420m	0	0	0	0	430m	0	0	0	0	440m	0	0	0	0	450m	0	0	0	0	460m	0	0	0	0	470m	0	0	0	0	480m	0	0	0	0	490m	0	0	0	0	500m	0	0	0	0	510m	0	0	0	0	520m	0	0	0	0	530m	0	0	0	0	540m	0	0	0	0	550m	0	0	0	0	560m	0	0	0	0	570m	0	0	0	0	580m	0	0	0	0	590m	0	0	0	0	600m	0	0	0	0	610m	0	0	0	0	620m	0	0	0	0	630m	0	0	0	0	640m	0	0	0	0	650m	0	0	0	0	660m	0	0	0	0	670m	0	0	0	0	680m	0	0	0	0	690m	0	0	0	0	700m	0	0	0	0	710m	0	0	0	0	720m	0	0	0	0	730m	0	0	0	0	740m	0	0	0	0	750m	0	0	0	0	760m	0	0	0	0	770m	0	0	0	0	780m	0	0	0	0	790m	0	0	0	0	800m	0	0	0	0	810m	0	0	0	0	820m	0	0	0	0	830m	0	0	0	0	840m	0	0	0	0	850m	0	0	0	0	860m	0	0	0	0	870m	0	0	0	0	880m	0	0	0	0	890m	0	0	0	0	900m	0	0	0	0	910m	0	0	0	0	920m	0	0	0	0	930m	0	0	0	0	940m	0	0	0	0	950m	0	0	0	0	960m	0	0	0	0	970m	0	0	0	0	980m	0	0	0	0	990m	0	0	0	0	1000m	0	0	0	0
Band	QSOs	CW	Phone	Total																																																																																																																																																																																																																																																																																																																																																																																																																																																							
160m	0	0	0	0																																																																																																																																																																																																																																																																																																																																																																																																																																																							
170m	0	0	0	0																																																																																																																																																																																																																																																																																																																																																																																																																																																							
175m	0	0	0	0																																																																																																																																																																																																																																																																																																																																																																																																																																																							
180m	0	0	0	0																																																																																																																																																																																																																																																																																																																																																																																																																																																							
185m	0	0	0	0																																																																																																																																																																																																																																																																																																																																																																																																																																																							
190m	0	0	0	0																																																																																																																																																																																																																																																																																																																																																																																																																																																							
200m	0	0	0	0																																																																																																																																																																																																																																																																																																																																																																																																																																																							
210m	0	0	0	0																																																																																																																																																																																																																																																																																																																																																																																																																																																							
220m	0	0	0	0																																																																																																																																																																																																																																																																																																																																																																																																																																																							
230m	0	0	0	0																																																																																																																																																																																																																																																																																																																																																																																																																																																							
240m	0	0	0	0																																																																																																																																																																																																																																																																																																																																																																																																																																																							
250m	0	0	0	0																																																																																																																																																																																																																																																																																																																																																																																																																																																							
260m	0	0	0	0																																																																																																																																																																																																																																																																																																																																																																																																																																																							
270m	0	0	0	0																																																																																																																																																																																																																																																																																																																																																																																																																																																							
280m	0	0	0	0																																																																																																																																																																																																																																																																																																																																																																																																																																																							
290m	0	0	0	0																																																																																																																																																																																																																																																																																																																																																																																																																																																							
300m	0	0	0	0																																																																																																																																																																																																																																																																																																																																																																																																																																																							
310m	0	0	0	0																																																																																																																																																																																																																																																																																																																																																																																																																																																							
320m	0	0	0	0																																																																																																																																																																																																																																																																																																																																																																																																																																																							
330m	0	0	0	0																																																																																																																																																																																																																																																																																																																																																																																																																																																							
340m	0	0	0	0																																																																																																																																																																																																																																																																																																																																																																																																																																																							
350m	0	0	0	0																																																																																																																																																																																																																																																																																																																																																																																																																																																							
360m	0	0	0	0																																																																																																																																																																																																																																																																																																																																																																																																																																																							
370m	0	0	0	0																																																																																																																																																																																																																																																																																																																																																																																																																																																							
380m	0	0	0	0																																																																																																																																																																																																																																																																																																																																																																																																																																																							
390m	0	0	0	0																																																																																																																																																																																																																																																																																																																																																																																																																																																							
400m	0	0	0	0																																																																																																																																																																																																																																																																																																																																																																																																																																																							
410m	0	0	0	0																																																																																																																																																																																																																																																																																																																																																																																																																																																							
420m	0	0	0	0																																																																																																																																																																																																																																																																																																																																																																																																																																																							
430m	0	0	0	0																																																																																																																																																																																																																																																																																																																																																																																																																																																							
440m	0	0	0	0																																																																																																																																																																																																																																																																																																																																																																																																																																																							
450m	0	0	0	0																																																																																																																																																																																																																																																																																																																																																																																																																																																							
460m	0	0	0	0																																																																																																																																																																																																																																																																																																																																																																																																																																																							
470m	0	0	0	0																																																																																																																																																																																																																																																																																																																																																																																																																																																							
480m	0	0	0	0																																																																																																																																																																																																																																																																																																																																																																																																																																																							
490m	0	0	0	0																																																																																																																																																																																																																																																																																																																																																																																																																																																							
500m	0	0	0	0																																																																																																																																																																																																																																																																																																																																																																																																																																																							
510m	0	0	0	0																																																																																																																																																																																																																																																																																																																																																																																																																																																							
520m	0	0	0	0																																																																																																																																																																																																																																																																																																																																																																																																																																																							
530m	0	0	0	0																																																																																																																																																																																																																																																																																																																																																																																																																																																							
540m	0	0	0	0																																																																																																																																																																																																																																																																																																																																																																																																																																																							
550m	0	0	0	0																																																																																																																																																																																																																																																																																																																																																																																																																																																							
560m	0	0	0	0																																																																																																																																																																																																																																																																																																																																																																																																																																																							
570m	0	0	0	0																																																																																																																																																																																																																																																																																																																																																																																																																																																							
580m	0	0	0	0																																																																																																																																																																																																																																																																																																																																																																																																																																																							
590m	0	0	0	0																																																																																																																																																																																																																																																																																																																																																																																																																																																							
600m	0	0	0	0																																																																																																																																																																																																																																																																																																																																																																																																																																																							
610m	0	0	0	0																																																																																																																																																																																																																																																																																																																																																																																																																																																							
620m	0	0	0	0																																																																																																																																																																																																																																																																																																																																																																																																																																																							
630m	0	0	0	0																																																																																																																																																																																																																																																																																																																																																																																																																																																							
640m	0	0	0	0																																																																																																																																																																																																																																																																																																																																																																																																																																																							
650m	0	0	0	0																																																																																																																																																																																																																																																																																																																																																																																																																																																							
660m	0	0	0	0																																																																																																																																																																																																																																																																																																																																																																																																																																																							
670m	0	0	0	0																																																																																																																																																																																																																																																																																																																																																																																																																																																							
680m	0	0	0	0																																																																																																																																																																																																																																																																																																																																																																																																																																																							
690m	0	0	0	0																																																																																																																																																																																																																																																																																																																																																																																																																																																							
700m	0	0	0	0																																																																																																																																																																																																																																																																																																																																																																																																																																																							
710m	0	0	0	0																																																																																																																																																																																																																																																																																																																																																																																																																																																							
720m	0	0	0	0																																																																																																																																																																																																																																																																																																																																																																																																																																																							
730m	0	0	0	0																																																																																																																																																																																																																																																																																																																																																																																																																																																							
740m	0	0	0	0																																																																																																																																																																																																																																																																																																																																																																																																																																																							
750m	0	0	0	0																																																																																																																																																																																																																																																																																																																																																																																																																																																							
760m	0	0	0	0																																																																																																																																																																																																																																																																																																																																																																																																																																																							
770m	0	0	0	0																																																																																																																																																																																																																																																																																																																																																																																																																																																							
780m	0	0	0	0																																																																																																																																																																																																																																																																																																																																																																																																																																																							
790m	0	0	0	0																																																																																																																																																																																																																																																																																																																																																																																																																																																							
800m	0	0	0	0																																																																																																																																																																																																																																																																																																																																																																																																																																																							
810m	0	0	0	0																																																																																																																																																																																																																																																																																																																																																																																																																																																							
820m	0	0	0	0																																																																																																																																																																																																																																																																																																																																																																																																																																																							
830m	0	0	0	0																																																																																																																																																																																																																																																																																																																																																																																																																																																							
840m	0	0	0	0																																																																																																																																																																																																																																																																																																																																																																																																																																																							
850m	0	0	0	0																																																																																																																																																																																																																																																																																																																																																																																																																																																							
860m	0	0	0	0																																																																																																																																																																																																																																																																																																																																																																																																																																																							
870m	0	0	0	0																																																																																																																																																																																																																																																																																																																																																																																																																																																							
880m	0	0	0	0																																																																																																																																																																																																																																																																																																																																																																																																																																																							
890m	0	0	0	0																																																																																																																																																																																																																																																																																																																																																																																																																																																							
900m	0	0	0	0																																																																																																																																																																																																																																																																																																																																																																																																																																																							
910m	0	0	0	0																																																																																																																																																																																																																																																																																																																																																																																																																																																							
920m	0	0	0	0																																																																																																																																																																																																																																																																																																																																																																																																																																																							
930m	0	0	0	0																																																																																																																																																																																																																																																																																																																																																																																																																																																							
940m	0	0	0	0																																																																																																																																																																																																																																																																																																																																																																																																																																																							
950m	0	0	0	0																																																																																																																																																																																																																																																																																																																																																																																																																																																							
960m	0	0	0	0																																																																																																																																																																																																																																																																																																																																																																																																																																																							
970m	0	0	0	0																																																																																																																																																																																																																																																																																																																																																																																																																																																							
980m	0	0	0	0																																																																																																																																																																																																																																																																																																																																																																																																																																																							
990m	0	0	0	0																																																																																																																																																																																																																																																																																																																																																																																																																																																							
1000m	0	0	0	0																																																																																																																																																																																																																																																																																																																																																																																																																																																							

TGA2312-FL

X-band 60W GaN Power Amplifier



60Watt auf 3cm ??? Der TGA2312 kostet derzeit ca. 1160€ bei Mouser

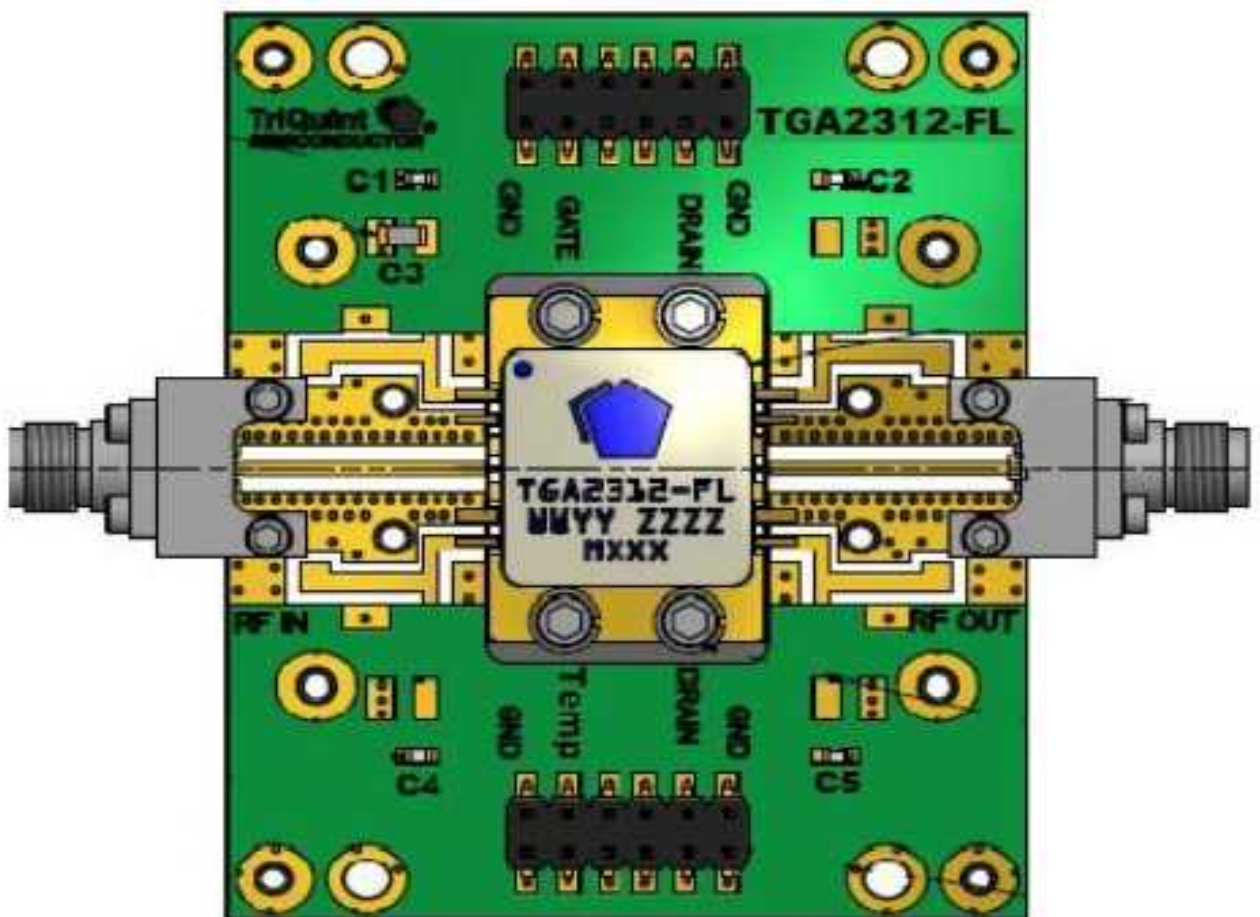

RO4350 0.020 inch thickness with 0.5 oz. copper.

Application Circuit

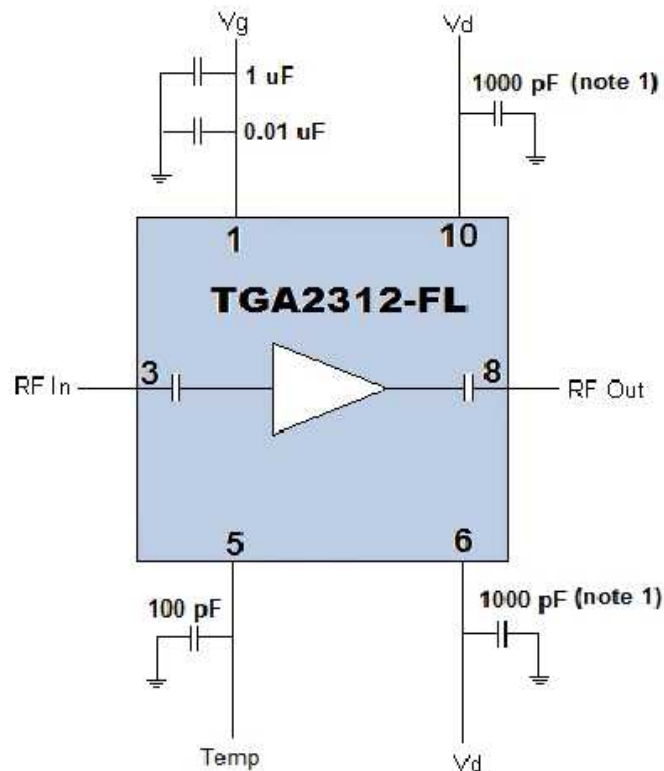

Note 1: One of these caps can be removed for drain pulsing.
Drain voltage can be applied to either Vd pins.

Conditions unless otherwise specified: $V_D = 24\text{ V}$, $I_{DQ} = 2.4\text{ A}$,

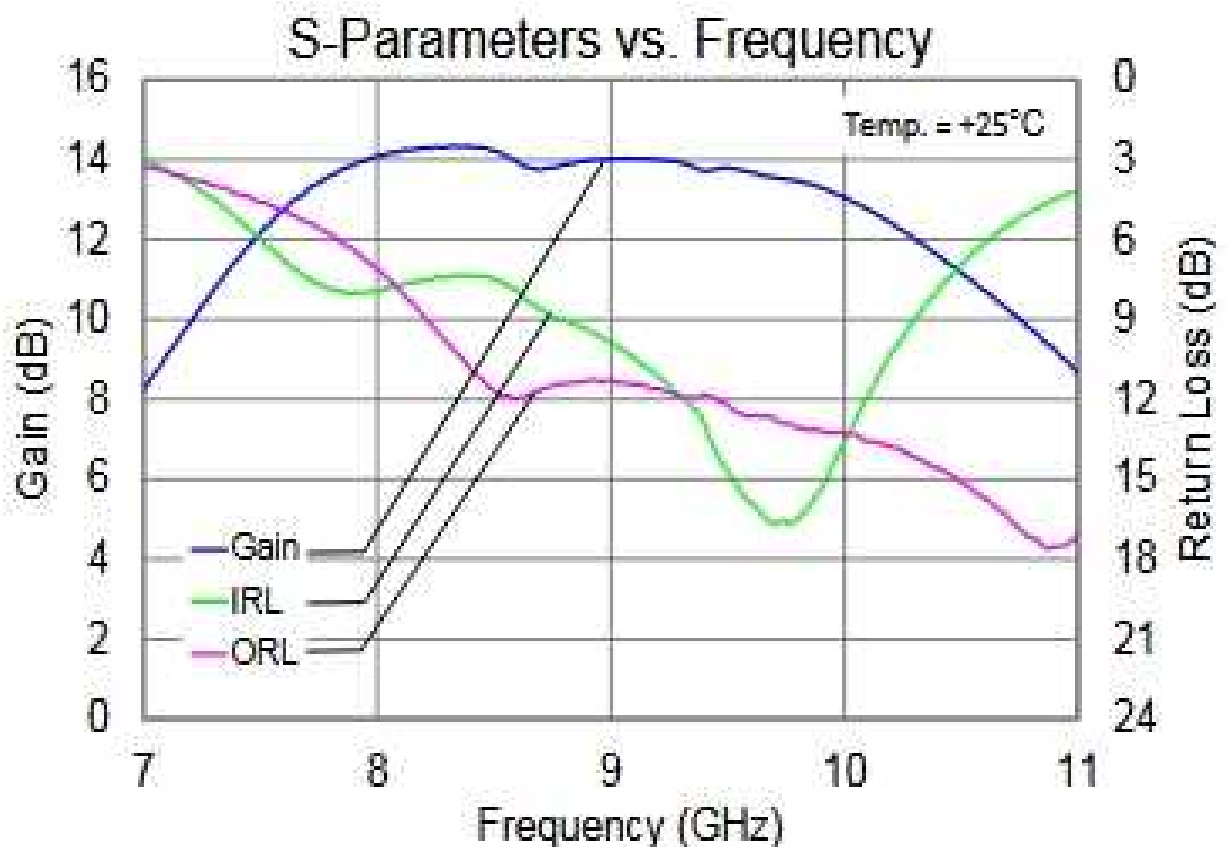

DUR – Jahreswertung 2024

DM4SWL	298	13057	15418	9695	8834	17145	9776	13245	8829	9568	0	0	105865
DL1DSR	0	13057	15418	9695	138	17145	0	13245	180	9568	0	0	78446
DM2MM	243	4754	5666	5370	3825	14656	7400	9182	0	6750	0	0	57846
DL7UDA	177	132	5804	0	3825	14656	7940	9182	2872	3173	0	0	47761
9A5M	0	0	1929	5358	7003	10751	0	6728	5413	8146	0	0	45328
DG2DWL	2000	3504	2759	1480	3007	7395	5481	3230	4363	4542	0	0	37761
YO3GNF	183	320	3829	5048	5918	6958	5001	2156	355	964	0	0	30732
9A8D	0	9294	4100	3103	257	5146	0	3305	0	0	0	0	25205
YO3FWL	259	0	1808	2913	3786	5987	3764	2541	970	1145	0	0	23173
DO1UKA	0	1554	2337	0	0	8388	4926	0	0	4710	0	0	21915
DL2XF	1840	5571	0	2488	740	970	0	3559	3678	3010	0	0	21856
DG0VV	0	0	0	0	7052	0	6361	8320	0	0	0	0	21733
DL1DUR	0	2862	0	3324	4920	0	8436	108	1863	0	0	0	21513
HA3FMR	0	1918	3546	3052	3174	0	2327	0	3865	3240	0	0	21122
DM2EUN	0	0	2429	1543	1921	7209	2645	1094	0	3203	0	0	20044
DG5BRE	1467	0	0	4857	4515	2035	2945	3770	0	0	0	0	19589
DL7VTX	0	0	6726	0	0	0	0	9182	0	2679	0	0	18587
DL1ATI	0	0	0	0	0	0	0	11931	6465	0	0	0	18396
DL2DRG	45	2778	1833	2415	30	1044	3726	2982	1257	1158	0	0	17268
YO8ENF	0	0	3829	2912	3055	6958	0	0	0	0	0	0	16754
HA2ML	1056	3214	2005	2845	0	3938	2146	0	919	0	0	0	16123
YO3GJ	80	320	833	2549	2118	3560	2181	2175	133	427	0	0	14376
HA5UA	0	0	0	0	1929	6795	5548	0	0	0	0	0	14272
DM3F	22	0	0	0	0	1383	5432	4611	0	0	0	0	11448
DD6ZJ	0	0	0	0	0	3177	4610	0	2872	0	0	0	10659
DL4DTU	0	0	0	0	0	0	10144	0	0	0	0	0	10144
YO7IY	0	0	2754	0	2313	3210	1735	0	0	0	0	0	10012
DL1JIF	812	1234	1091	836	1228	1036	786	1245	948	760	0	0	9976
DH1DM	0	0	0	0	2055	7395	0	0	0	0	0	0	9450
YO8YNF	0	0	3829	4634	605	0	0	0	355	0	0	0	9423
DL1AT	2029	0	0	0	0	2426	0	3152	1533	0	0	0	9140
DG1VC	45	2097	3837	2664	0	0	354	132	0	0	0	0	9129
DO2UDX	0	798	0	0	778	0	0	3194	1994	2158	0	0	8922
DL6AST	1348	2182	1897	2267	0	0	0	0	0	438	0	0	8132
DL1HSF	0	2509	0	0	0	0	0	0	1448	3718	0	0	7675
YR7J	0	0	0	510	3733	2962	0	0	0	0	0	0	7205
DL2HSC	208	1412	966	1362	574	0	1277	1048	0	0	0	0	6847
DL2JCD	487	0	412	227	1925	879	811	1098	978	0	0	0	6817
DH0LS	0	0	0	0	0	0	6507	0	0	0	0	0	6507
YO7HHE	0	0	0	0	986	2928	1735	0	0	0	0	0	5649
YO7BM	0	0	2754	0	949	0	1735	0	0	0	0	0	5438
DJ5AM	0	1159	0	0	0	2764	0	0	0	1381	0	0	5304
DM100MW	812	1234	1091	836	1228	0	0	0	0	0	0	0	5201
YO9AYN	317	0	1446	0	681	0	735	0	570	1308	0	0	5057
YO7FWS	0	0	0	822	1725	1656	411	360	0	0	0	0	4974
DL6DVU	414	404	324	733	0	622	768	0	557	217	0	0	4039
9A1I	201	497	368	532	609	493	270	477	0	418	0	0	3865
DL1OHS	0	1916	1650	0	0	0	0	0	0	0	0	0	3566
YO3GWM	0	0	0	0	2118	888	0	0	0	442	0	0	3448
DL7UGZ	0	0	0	0	0	0	1548	1842	0	0	0	0	3390
DH5YM	0	0	2025	0	905	0	0	0	0	0	0	0	2930
DL1WU	0	502	2165	248	0	0	0	0	0	0	0	0	2915
YO9CWY	0	0	0	0	0	1846	393	0	655	0	0	0	2894
YO7PYM	0	0	2754	0	0	0	0	0	0	0	0	0	2754
YO7PDN	0	0	2754	0	0	0	0	0	0	0	0	0	2754
DG1RTV	0	0	599	2111	0	0	0	0	0	0	0	0	2710
YO7CW	0	0	2703	0	0	0	0	0	0	0	0	0	2703
DM3AWK	0	2638	0	0	0	0	0	0	0	0	0	0	2638
YO3CBS	0	0	0	1284	0	0	0	437	720	0	0	0	2441
DM6JKC	0	422	468	0	264	0	718	150	0	376	0	0	2398
DK1RS	0	1457	0	828	0	0	0	0	64	0	0	0	2349
DH0DK	0	168	494	860	0	0	0	0	816	0	0	0	2338
YO8CLN	0	0	0	0	0	0	0	1148	0	1038	0	0	2186
DL6AKK	0	212	0	0	0	1052	661	0	0	0	0	0	1925
DL3DTS	0	0	0	0	0	0	1670	0	0	0	0	0	1670
DL1DXA	0	0	1057	318	0	0	0	0	0	0	0	0	1375
DL1HUF	0	0	0	0	0	0	0	0	251	1052	0	0	1303
DC5IMM	0	688	0	0	0	0	0	564	0	0	0	0	1252
YO9GOO	0	0	0	0	0	888	0	304	0	0	0	0	1192
DL8WQQ	84	95	95	95	167	200	95	95	167	95	0	0	1188
DF0MTL	84	95	95	95	167	200	95	95	167	95	0	0	1188
DL1HTT	0	0	0	0	0	0	0	0	0	1160	0	0	1160
DL100ANA	0	0	0	0	288	434	412	0	0	0	0	0	1134
DO3BST	0	0	0	0	0	0	1093	0	0	0	0	0	1093
DG0LCR	0	1060	0	0	0	0	0	0	0	0	0	0	1060
YO8RHM	0	0	0	0	0	0	0	0	0	1038	0	0	1038
DL3VL	0	0	0	0	0	0	0	0	1018	0	0	0	1018
DL1JHR	0	0	0	0	150	434	412	0	0	0	0	0	996
YO3FUU	0	0	833	0	0	0	0	0	0	0	0	0	833
DL6JUN	0	0	0	0	0	0	0	828	0	0	0	0	828
DR100FK	0	346	468	0	0	0	0	0	0	0	0	0	814
YR0C	0	0	0	0	0	0	0	0	720	0	0	0	720
YO3BZW	0	0	0	0	0	0	0	0	720	0	0	0	720
YO3KWJ	0	0	0	0	0	0	0	0	720	0	0	0	720
YO3CYR	0	0	0	654	0	0	0	0	0	0	0	0	654
DL4PT	0	0	0	0	138	132	206	49	0	0	0	0	525
DL3MR	59	100	77	20	104	0	0	39	0	52	0	0	451
DL5DTL	0	0	0	0	0	0	0	178	0	92	0	0	270
DG0YT	0	0	0	0	0	0	0	0	180	0	0	0	180
DL4VCG	0	0	0	0	0	0	0	162	0	0	0	0	162
DL1PI	0	0	108	0	0	0	0	0	0	0	0	0	108
HA9MDP	0	0	0	100	0	0	0	0	0	0	0	0	100
SP3LD	0	0	0	0	0	0	0	0	60	0	0	0	60
SP1N	0	0	0	0	0	0	0	0	60	0	0	0	60
9A3AQ	0	0	0	0	0	0	0	0	60	0	0	0	60
SP3LX	0	0	0	0	0	0	0	0	60	0	0	0	60
DF0GC	0	0	0	0	0	38	0	0	0	0	0	0	38

Nächster DUR - Wettbewerb am 17.11.2024: 08⁰⁰- 11⁰⁰ UTC